





Washing Machine

OWNER'S MANUAL

MODEL : WT-R107

Please read this manual carefully before operating your set.
Retain it for future reference.
Record model name and serial number of the set.
Quote this information to your dealer when you require service.

Product Features



The Turbo Drum DD washing machine does not operate with the lid open. If the lid is opened during wash, rinse and spin cycles, the machine will stop automatically.



Please close the door gently to avoid injury and machine damage.

Fuzzy Logic Control

- A built-in load sensor automatically detects and measures the laundry load and a microprocessor optimizes washing conditions such as ideal water consumption and washing time.
- Advanced technology is built into the Electronic Control System which ensures the best washing result.

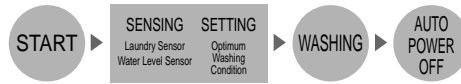

Turbo Drum DD washing



Stains are removed by pulsator movement

Stains are removed by the tub movement

With high speed spinning of the tub, stains are removed

Low Noise Direct Drive System

- The advanced BLDC motor rotates the Tub or Pulsator directly without belt and clutch, thereby reducing the noise of the washer.
- The washing machine adjusts to optimum speed according to the type of clothing in the load.



C ontents

READ THIS MANUAL

Inside you will find many helpful hints on how to use and maintain your washer properly. Just a little preventive care on your part can save you a great deal of time and money over the life of your washer.

You will find many answers to common problems in the Troubleshooting section. If you review our chart of Troubleshooting Tips first, you may not need to call for service at all.

Introduction	Safety Information	4
	Identification of Parts	7
Before Starting to Wash	Preparation Before Washing	8
	Use of Water, Detergent, Bleach, Softener, Additives	9
	Special Guide for Stain Removal	13
	Function of each Button	14
Washing Programs	Bulky/Large	16
	Heavy Duty	16
	Fuzzy	16
	Eco Cotton	16
	Perm. Press	16
	Delicates	18
	Wool / Silk	18
	Hand Wash	18
	Speed Wash	18
Rinse/ Spin	18	
Option Programs	Delay Wash(Reservation)	20
	Soak Wash	21
	Extra Rinse	22
	Custom Program	23
	Spin only	24
	Child lock	25
Installation	Placing and Leveling	26
	Connecting Water Supply Hose	27
	Connecting Drain Hose	30
Care and Maintenance	Grounding Method	31
	Cleaning and Maintenance	32
Troubleshooting	Common Washing Problems	34
	Troubleshooting	35
Terms of Warranty	Terms of Warranty	36
Specification	Specification	37

Safety Information

Read carefully and thoroughly through this booklet as it contains important safety information that will protect the user from unexpected dangers and prevent potential damages to the product.

This booklet is divided into 2 parts : Warning and Caution.



: This is a warning sign specifying user's applications which might be dangerous.





: This is a sign specifying 'Strictly Forbidden' applications.









Warning : Failure to comply with the instructions under this sign may result in major physical injuries or death.



Caution : Failure to comply with the instructions under this sign may result in minor physical injuries or damages to the product.

<p>WATER HEATER SAFETY</p>	<p> Warning</p> <ul style="list-style-type: none"> • Under certain conditions hydrogen gas may be produced in a water heater that has not been used for two weeks or more. Hydrogen gas can be explosive under these circumstances. If the HOT water has not been used for two weeks or more, prevent the possibility of damage or injury by turning on all Hot water faucets and allowing them to run for several minutes. Do this before using any electrical appliance which is connected to the HOT water system. This simple procedure will allow any built-up hydrogen gas to escape. Since the gas is flammable, do not smoke or use an open flame or appliance during this process.
<p>PROPER INSTALLATION</p>	<p> Caution</p> <ul style="list-style-type: none"> • The base opening must not be obstructed by carpeting when the washing machine is installed on a carpeted floor. • Install or store where it will not be exposed to temperatures below freezing or exposed to the weather. If the product is exposed to such conditions, electric shock, fire, break down or deformation may occur. • Properly ground washer to conform with all governing codes and ordinances. Follow details in Installation Instructions. If not grounded properly, break down and leakage of electricity may occur, which may cause electric shock. • Must be positioned so that the plug is accessible. If the plug is placed between the wall and the machine, it may get damaged, possibly causing fire or electric shock. • Make sure the plug is completely pushed into the outlet. Failure to do so may cause electric shock and fire due to overheating.

Safety Information

<p>YOUR LAUNDRY AREA</p>	<div style="text-align: center;">  <h2>Warning</h2> </div> <ul style="list-style-type: none"> • Keep the area underneath and around your appliances free of combustible materials such as lint, paper, rags, chemical, etc. Operating with such materials around the machine may trigger explosion or fire. • Close supervision is necessary if this appliance is used by or near children. Do not allow children to play on, with, or inside this or any other appliance. There is potential danger that children might drown in the tub. <p> Do not touch the power plug with a wet hand. It will cause electric shock</p> <p> Do not put your hand, foot or anything under the washing machine while the washing machine is in operation. There is a rotating mechanism under the machine, so you could be injured.</p>
<p>WHEN USING THE WASHER</p>	<div style="text-align: center;">  <h2>Caution</h2> </div> <ul style="list-style-type: none"> • Use this appliance only for its intended purpose as described in this Owner's Manual. • The laundry process can reduce the flame retardancy of fabrics. To avoid such a result, carefully follow the garment manufacturer's wash and care instructions. • To minimize the possibility of electric shock, unplug this appliance from the power supply or disconnect the washer at the household distribution panel by removing the fuse or switching off the circuit breaker before attempting any maintenance or cleaning. <p>NOTE : Pressing Power button to turn off does NOT disconnect the appliance from the power supply.</p> <ul style="list-style-type: none"> • Make sure that drainage is working properly. If water is not drained properly, your floor may get flooded. Flooded floors may induce electricity leakage, further resulting in electric shock or fire. • If, during spinning, opening the lid does not stop the tub within about 15 seconds, immediately discontinue operating the machine. Call for repair. A machine that spins with its door open may cause injuries. <p> Never reach into washer while it is moving. Wait until the machine has completely stopped before opening the lid. Even slow rotation can cause injury.</p> <p> Never attempt to operate this appliance if it is damaged, malfunctioning, partially disassembled, or has missing or broken parts, including a damaged cord or plug. Operating with a damaged plug may cause electric shock.</p> <p>Do not use water hotter than 50°C.</p> <p> Use of excessively hot water may cause damage to fabrics or cause leakage of water.</p>

Safety Information

WHEN USING THE WASHER



Warning



Do not use a plug socket and wiring equipment for more than their rated capacity.
Exceeding the limit may lead to electric shock, fire, break down, and/or deformation of parts.



Do not mix chlorine bleach with ammonia or acids such as vinegar and/or rust remover.
Mixing different chemicals can produce toxic gases which may cause death.



Do not wash or dry articles that have been cleaned in, washed in, soaked in, or spotted with combustible or explosive substances (such as wax, oil, paint, gasoline, dry-cleaning solvents, kerosene, etc). Do not add these substances to the wash water.
Do not use or place these substances around your washer or dryer during operation.
It may ignite or explode.

WHEN NOT IN USE



Caution

- Turn off water faucets to relieve pressure on hoses and valves and to minimize leakage if a break or rupture should occur. Check the condition of the fill hoses; they may need replacement after 5years.
- When the air temperature is high and the water temperature is low, condensation may occur and thus wet the floor.
- Wipe off dirt or dust on the contacts of the power plug.
Using unclean power plug may cause fire.
- Before discarding a washer, or removing it from service, remove the washer lid to prevent children from hiding inside.

Children may be trapped and suffocated if the lid is left intact.



Do not attempt to repair or replace any part of this appliance unless specifically recommended in this Owner's Manual, or in published user-repair instructions that you understand and have the skills to carry out.

Operating the machine with improperly replaced parts may be a cause for fire or electric shock.



Do not tamper with controls.
It may lead to electric shock, fire, break down, deformation.



Do not yank the power cord in an attempt to disconnect the power plug.
Securely hold the power plug to unplug the machine.
Failure to observe these instructions may cause electric shock or fire due to short-circuit.



When you are cleaning the washing machine, do not apply water directly to any part of the washing machine.
It will cause short circuit and electric shock.

Identification of Parts

Body

DETERGENT BOX

Detergent box for delayed washing / Softener box / Additives box

TUB

INLET HOLE FOR BLEACH

PULSATOR

Vertical movement of washing action can be operated when a sufficient amount of laundry is deposited. Set the proper water level, an excessive amount of water may increase entanglement of laundry.

LEVELLING LEGS

Use to level the washing machine for correct balance & spin operation.

COLD WATER SUPPLY HOSE

Make sure the water does not leak.

HOT WATER SUPPLY HOSE

POWER PLUG

If the supply cord is damaged, it must be replaced by the manufacturer or its service agents or similarly qualified person in order to avoid a hazard.

FUNCTION SELECTOR

DRAIN HOSE

Check if the drain hose is hung up before operating the washing machine.

BASE

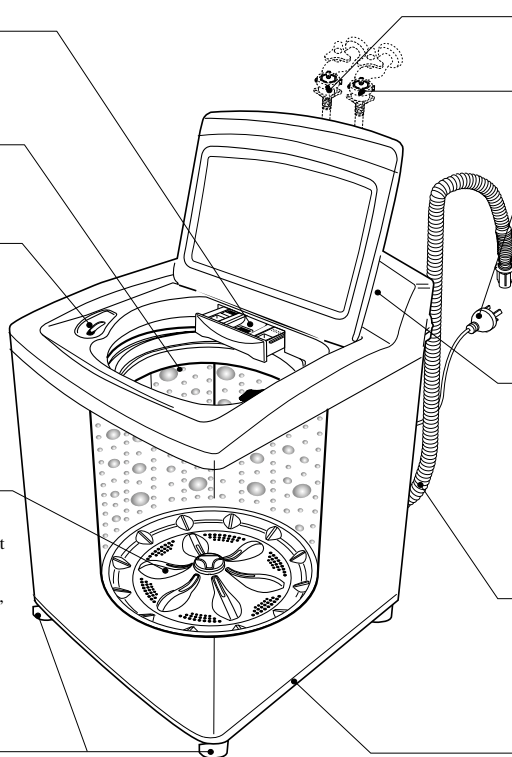

Accessories

Inlet hose

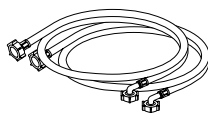

1 Each for cold and hot water

Drain hose

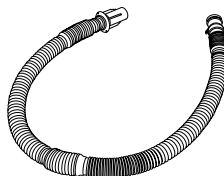

Cable tie

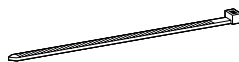

Preparation Before Washing

Care Labels

- Look for a care label on your clothes. This will tell you about the fabric content of your garment and how it should be washed.
- Sort clothes into loads that can be washed with the same wash cycle, Water Temperature and spin speed.



Sorting

To get the best results, different fabrics need to be washed in different ways.

- **SOIL** (Heavy, Normal, Light) Separate clothes according to the type and amount of soil.
- **COLOR** (Whites, Lights, Darks) Separate white fabrics from colored fabrics.
- **LINT** (Lint producers, Collectors) Separate lint producers and lint collectors.

Lint Producers

Terry cloth, Chenille, Towels, Nappies

Lint Collectors

Synthetics, Corduroy, Permanent Press, Socks



Check before Loading

- **Check all pockets to make sure that they are empty.** Things such as nails, hairclips, matches, pens, coins, and keys can damage both your washer and your clothes.
- **Mend any torn garments or loose buttons.** Tears or holes may become larger during washing.
- Remove belts, underwires, etc. to prevent damage to the machine or your clothes.
- **Pretreat any dirt and stains.**
- Make sure the clothes are washable in water.
- Check the washing instructions.
- Remove tissue in pockets.



Pretreatment on stains or heavy soil

- Pretreat shirt collars and cuffs with a pre-wash product or liquid Detergent when placing them in the washer. Before washing treat special stains with bar soaps, liquid Detergent or a paste of water and granular Detergent.
- Use a pretreat soil and stain remover. Treat stains AS SOON AS POSSIBLE. The longer they are left the harder they are to remove. *(For more detail refer to page 13)*

Loading

Do not wash fabrics containing flammable materials (waxes, cleaning fluids, etc.).

Load Size

The WATER LEVEL should just cover the clothes. Adjust the load size accordingly. Loosely load clothes no higher than the top row of holes in the washer tub. To add items after washer has started, press "START/PAUSE" button and submerge additional items. Close the lid and press "START/PAUSE" button again to restart.

Light and Large-sized clothing

Clothes like downs and woollens are light weight, large and float easily. Use a nylon net and wash them in a small amount of water. If the laundry floats during the wash cycle, it may become damaged. Use dissolved Detergent to prevent the Detergent from clumping.

※ Do not wash water-proof textiles (Suckling outfit, baby's nappy automobile seat covers.)

Long laundry items

Use nylon nets for long, DELICATES items. For laundry with long strings or long length, a net will prevent tangling during washing. **Fasten zippers, hook, and strings** to make sure that these items don't snag on other clothes.

※ Nylon net is not supplied by LG.

WARNING

Fire Hazard

Never place items in the washer that are dampened with gasoline or other flammable fluids.

No washer can completely remove oil. Do not dry anything that has ever had any type of oil on it (including cooking oils).

Doing so can result in death, explosion, or fire.

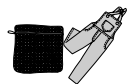

Use of Water, Detergent, Bleach, Softener, Additives

Using Water

Amount of WATER LEVEL

- This machine detects the quantity of laundry automatically, then sets the proper amount of water.

Water Temperature

- The machine sets the appropriate temperature automatically according to the wash program .
You can change the Water Temperature by pressing the WASH/RINSE button.
- The temperature of the water impacts the effectiveness of all laundry additives and therefore, the cleaning results.
- We recommend temperatures of:
 - HOT 49~60°C ...(120-140°F) White items, diapers, underclothing and heavily soiled, colorfast items.
 - WARM 29~40°C ...(85-105°F) Most items
 - COLD* 18~24°C ...(65-75°F) Bright colors with light soil.
- When washing in COLD water additional steps may be needed:
 - Adjust Detergent amount and pre-dissolve Detergent in WARM water
 - Pretreat spots and stains
 - Soak heavily soiled items
 - Use appropriate bleach

* Temperature below 18°C ...(65°F) will not activate laundry additives and may cause lint, residue, poor cleaning, etc. In addition, Detergent manufactures and care labels define COLD water as 26~29°C...(80-85°F).
If the temperature of the water in the tub is too cold for your hands, the Detergent will not activate and clean effectively.

Note

If iron is present in the water the clothes may become an all-over yellow or they may be stained with brown or orange spots or streaks. Iron is not always visible. Installation of water softener or an iron filter may be necessary for severe cases.

Use of Water, Detergent, Bleach, Softener, Additives

Using Detergent

Detergent

Follow the Detergent package directions. Using too little Detergent is a common cause of laundry problems. Use more Detergent if you have hard water, large loads, greasy or oily soils or lower Water Temperature.

Choosing the right Detergent

We recommend the use of drum type, low suding, high efficiency Detergent (powder, liquid or concentrated). Soap flakes or granulated soap powders should not be used in your washing machine. When washing woolsens remember to use Detergent suitable for washing woolsens.

Using the Liquid Bleach Dispenser

The bleach dispenser automatically dilutes and dispenses liquid chlorine bleach at the proper time in the wash cycle.

1. Check clothing care labels for special instructions.
2. Measure liquid bleach carefully, following instructions on the bottle.
 - Never pour undiluted liquid chlorine bleach directly onto clothes or into the wash basket.
 - Do not pour powdered bleach into bleach dispenser.
 - Avoid overfilling or splashing when adding bleach to the dispenser. The maximum capacity of the bleach dispenser is one cup of bleach per wash cycle. Overfilling could result in early dispensing of bleach.
3. Before starting the washer, pour measured amount of bleach directly into bleach dispenser. If you prefer to use powdered bleach, add it into the wash basket directly before adding clothes.

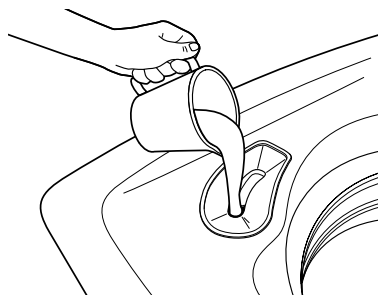

⚠️ WARNING! *Do not mix chlorine bleach with ammonia or acids such as vinegar and/or rust remover. Mixing can produce a toxic gas which may cause death*

The manufacturer's recommended amount of undiluted bleach goes into the bleach dispenser. During the final "Infuser" wash action the bleach is added to the wash load. This ensures performance won't be diminished. Two sequential flushes through the bleach dispenser completely removes the bleach from the dispenser. Any residual liquid left in the dispenser at the end of the cycle is water, not bleach. To prevent self-siphoning of the bleach into the wash basket and damage to your clothes, never add more than the maximum fill level marked on the dispenser.

Also keep clothes away from the bleach dispenser so they don't absorb any bleach droplets left around the bleach dispenser.

Using the Dispenser Drawer

The dispenser drawer contains three compartments:

- Liquid Fabric Softener
- Powder Detergent
- Liquid Wash Boost Additives

The dispenser automatically dispenses additives at the proper time in the wash cycle.

1. Slowly open the dispenser drawer by pulling the drawer out until it stops.
2. After adding laundry products, slowly close the dispenser drawer. Closing the drawer too quickly could result in early dispensing of additives.
 - Avoid overfilling or splashing when adding laundry products to the dispenser. Doing so could result in early dispensing of laundry products.

At the end of the cycle, you may see water in the compartments. This is part of the normal operation of the washer.

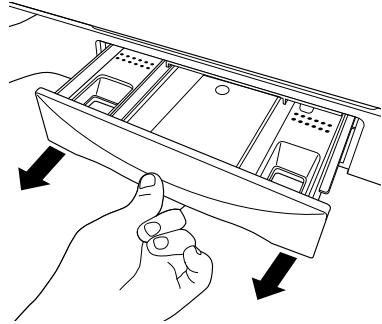

NOTE: Do not use bleach in the dispenser drawer.

Adding Detergent

Add measured detergent to the detergent compartment of the dispenser drawer.

- **Do not exceed the maximum fill line.**

Detergent is flushed through the dispenser at the beginning of the wash phase. Either powdered or liquid detergent can be used.

Detergent usage may need to be adjusted for water temperature, water hardness, size and soil level of the load. Avoid using too much detergent in your washer, as it can lead to oversudsing and detergent residue being left on the clothes.

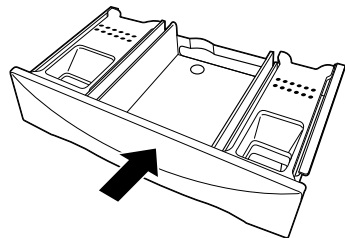

Use of Water, Detergent, Bleach, Softener, Additives

Adding Fabric Softener

If desired, pour the recommended amount of liquid fabric softener into the left-hand compartment. Use only liquid fabric softener.

Dilute with water to the maximum fill line.

- **Do not exceed the maximum fill line.**

Overfilling can cause early dispensing of the fabric softener, which could stain clothes.

NOTE: Do not pour fabric softener directly on the wash load. It may stain the clothes.

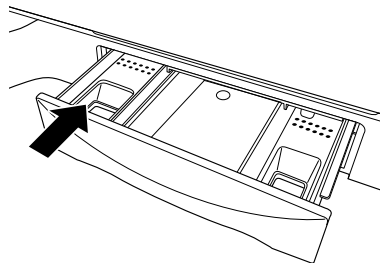

Adding Wash Boost Additives

The Wash Boost dispenser may be used to clean heavily soiled or stained garments more efficiently.

Place the additives for the wash Boost setting in the right-hand compartment.

Using the Soak cycle add soaking detergent in the right-hand compartment.

- **Do not exceed the maximum fill line to avoid**

Overfilling can cause early dispensing of soak additives, which could result in damaged clothes.

NOTE: Do not pour additives directly on the wash load. It may stain the clothes.

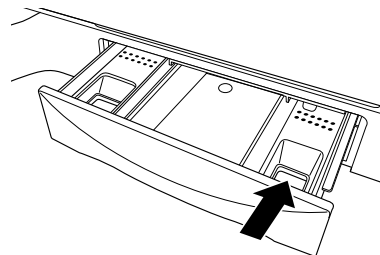

Special Guide for Stain Removal

⚠ WARNING

- Do not use or mix liquid chlorine bleach with other household chemicals such as toilet cleaners, rust removers, acid or products containing ammonia. These mixtures can produce dangerous fumes which can cause serious injury or death.
- To reduce the risk of fire or serious injury to persons or property, comply with the basic warnings listed below:
 - Read and comply with all instructions on stain removal products.
 - Keep stain removal products in their original labeled containers and out of children's reach.
 - Thoroughly wash any utensil used.
 - Do not combine stain removal products, especially ammonia and chlorine bleach. Dangerous fumes may result.
 - Never wash items which have been previously cleaned in, washed in, soaked in or spotted with gasoline, dry cleaning solvents or other flammable or explosive substances because they give off vapors that could ignite or explode.
 - Never use highly flammable solvents, such as gasoline, inside the home. Vapors can explode on contact with flames or sparks.

For successful stain removal:

- Remove stains promptly.
- Determine the kind of stain, then follow the recommended treatment in the stain removal chart below.
- To pretreat stains, use a prewash product, liquid Detergent, or a paste made from granular Detergent and water.
- Use COLD water on unknown stains because HOT water can set stains.
- Check care label instructions for treatments to avoid on specific fabrics.
- Check for colorfastness by testing stain remover on an inside seam.
- Rinse and wash items after stain removal.



Follow fabric care label instructions

Stain Removal

STAIN	TREATMENT
Adhesive tape, chewing gum, rubber cement	Apply ice. Scrape off excess. Place stain face down on paper towels. Saturate with prewash stain remover or nonflammable dry cleaning fluid.
Baby formula, dairy products, egg	Use product containing enzymes to pretreat or soak stains.
Beverages (coffee, tea, soda, juice, alcoholic beverages)	Pretreat stain. Wash using COLD water and bleach safe for fabric.
Blood	Rinse with COLD water. Rub with bar soap. Or pretreat or soak with product containing enzymes. Wash using bleach safe for fabric.
Candle wax, crayon	Scrape off surface wax. Place stain face down between paper towels. Press with warm iron until wax is absorbed. Replace paper towels frequently. Treat remaining stain with prewash stain remover or nonflammable dry cleaning fluid. Hand wash to remove solvent. Wash using bleach safe for fabric.
Chocolate	Pretreat or soak in WARM water using product containing enzymes. Wash using bleach safe for fabric.
Collar or cuff soil, cosmetics	Pretreat with prewash stain remover or rub with bar soap.
Dye transfer on white fabric	Use packaged color remover. Wash using bleach safe for fabric.
Grass	Pretreat or soak in WARM water using product containing enzymes. Wash using bleach safe for fabric.
Grease, oil, tar (butter, fats, salad dressing, cooking oils, car grease, motor oils)	Scrape residue from fabric. Pretreat. Wash using hottest water safe for fabric. For heavy stains and tar, apply nonflammable dry cleaning fluid to back of stain. Replace towels under stain frequently. Rinse thoroughly. Wash using hottest water safe for fabric.
Ink	Some inks may be impossible to remove. Washing may set some inks. Use prewash stain remover, denatured alcohol or nonflammable dry cleaning fluid.
Mildew, scorch	Wash with chlorine bleach if safe for fabric. Or, soak in oxygen bleach and HOT water before washing. Badly mildewed fabrics may be permanently damaged.
Mud	Brush off dry mud. Pretreat or soak with product containing enzymes.
Mustard, tomato	Pretreat with prewash stain remover. Wash using bleach safe for fabric.
Nail polish	May be impossible to remove. Place stain face down on paper towels. Apply nail polish remover to back of stain. Repeat, replacing paper towels frequently. Do not use on acetate fabrics.
Paint, varnish	WATER BASED : Rinse fabric in cool water while stain is wet. Wash. Once paint is dry, it cannot be removed, OIL BASED AND VARNISH : Use solvent recommended on can label. Rinse thoroughly before washing.
Rust, brown or yellow discoloration	For spots, use rust remover safe for fabric. For discoloration of an entire load, use phosphate Detergent and nonchlorine bleach. Do not use chlorine bleach because it may intensify discoloration.
Shoe polish	LIQUID : Pretreat with a paste of granular Detergent and water. PASTE : Scrape residue from fabric. Pretreat with prewash stain remover or nonflammable dry cleaning fluid. Rub Detergent into dampened area, Wash using bleach safe for fabric.

F

unction of each Button

POWER BUTTON

- Use to turn the power on or off.
- Push again and power goes on or off
- The power goes off automatically after the wash is finished.
- After turning the power on, if you don't push any button the power goes off automatically.

DELAY WASH (Reservation) BUTTON

- Use to set a delayed finishing time.
- The time increases when the button is pushed.
- The following settings are indicated as the button is pushed 1 ▶ 2 ▶ 3 ▶ 4 ▶ ... 12 ▶ 14 ▶ 16 ▶ 18 ▶ ... 24 HOUR ▶ Reservation off ▶ 1 ...
- To cancel delay time, turn the power switch off or push DELAY WASH button until Reservation off. (refer to page 20)

SOAK BUTTON

- It gives additional Soak.
- The following settings are indicated as the button is pushed 15 ▶ 30 ▶ 45 ▶ 60 ▶ 120 ▶ 180min. ▶ Soak off ▶ 15 (refer to page 21)

EXTRA RINSE BUTTON

- It gives additional rinse cycle. (For better rinsing effect) (refer to page 22)

Custom Program BUTTON

- This button allows you to store a customized wash cycle for future use. (refer to page 23)

SOIL LEVEL BUTTON

- This button allows you to select the strength of the wash action.
- Power option selections light up in sequence as follows Normal ▶ Heavy ▶ Light ▶ Normal as the button is pushed. This can be selected for any program.
- Adjustment can be made while washing.
- Default SOIL LEVEL is Normal.

LOAD SENSING

- It operates in all program (except BULKY/LARGE)
- During being detected by the sensor, the 'LOAD SENSING' LED flashes.
- It automatically sensing the quantity of laundries.
- During this step, the washing machine select optimized washing algorithm.

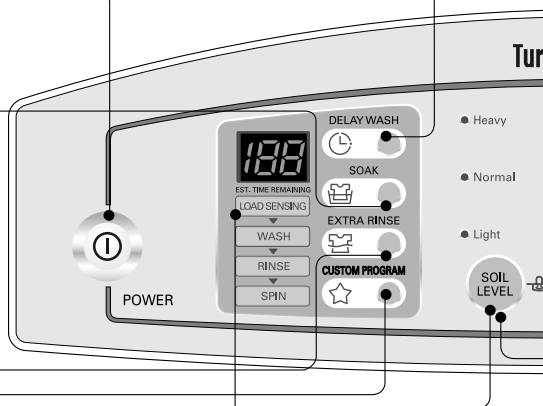

Note

* For optimizing the washing algorithm, the displaying time may be changed.

SPIN SPEED

- Spin speed can be selected from No Spin to Extra high. Default is "Low". (refer to page 24)

BEEPER BUTTON

- Beeper alerts you that the cycle is complete. The clothes should be removed when the beeper goes off so wrinkles won't set on.
- Beeper selection light up in sequence as follows: Low ► High ► Off ► Low
- Touch "Beeper" to select the volume or to turn the beeper off.

START/ PAUSE BUTTON

- Use to start or pause the wash cycle. Changes can be made to the wash settings whilst the machine is paused.
- Repeats start and pause by pushing the button.

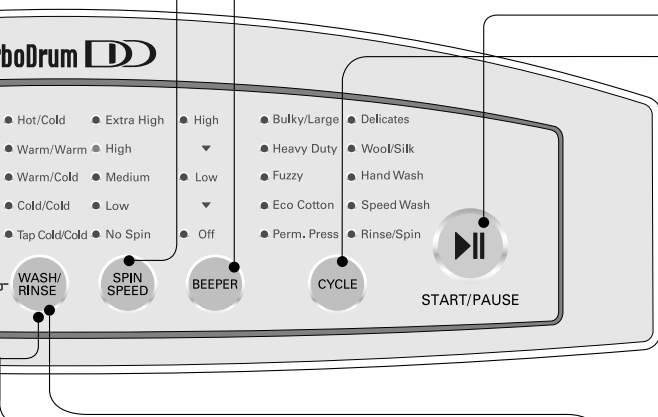

CYCLE BUTTON

- Use for selecting wash program.
- This button allows you to select 10 different programs for different kinds of laundry and dirtiness.
- Program selections light up in sequence as follows:
Fuzzy ► Eco Cotton ► Perm.Press ► Delicates ► Wool/Silk ► Hand Wash ► Speed Wash ► Rinse/Spin ► Bulky/Large ► Heavy Duty ► Fuzzy etc.
Select the desired program by pressing the button.

CHILD LOCK FUNCTION

- Use to lock or unlock the control buttons to prevent settings from being changed by a child.
- To lock, push the SOIL LEVEL and WASH / RINSE buttons simultaneously during the wash mode and to unlock push them one more time during the washing process. (refer to page 25)





















WASH / RINSE BUTTON

















- Use to select Water (Wash / Rinse) Temperature.
- Pressing the button allows you to select Warm/Cold ► Warm/Warm ► Hot/Cold ► Tap Cold/Cold ► Cold/Cold respectively. Default setting is Warm/Cold.

* The standard detected by the sensor changing the algorithm is set by the normal standard. It may not be same to the washing habit of a specific user. So, it does not matter that the user uses it according to her/his washing habit.

Washing programs













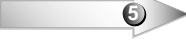
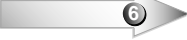
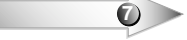

Our machine provides various washing methods which suits various conditions and types of laundry

Function information	Add the laundry	Add the Detergent	Close the lid	 POWER
<p>Bulky/Large</p> <p>This mode is for a big size garment.</p>				
<p>Heavy Duty</p> <p>Use this Program for heavily soiled durable garments e.g overalls, jeans.</p>				
<p>Fuzzy</p> <p>This program is for mixed fabrics and automatically selects the most appropriate wash conditions such as wash action and cycle times by utilizing the built-in load sensor.</p>				
<p>Eco Cotton</p> <p>Eco Cotton is the program for normally soiled cotton material and designed to minimize water consumption.</p>				
<p>Perm. Press</p> <p>Use this mode for sport wears or synthetic textiles.</p>				

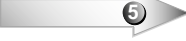
 Select the program on the Control panel.	 START/PAUSE	Finish	Caution & Note
			<ul style="list-style-type: none"> • Use this mode for bed clothes and big laundries.
			<ul style="list-style-type: none"> • Thick and heavy clothes or those which are excessively dirty like jeans or working uniforms can be washed.
			<ul style="list-style-type: none"> • Usage of Water is already optimized to every level.
			
			

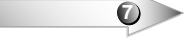
Washing programs

Function information	Add the laundry	Add the Detergent	Close the lid	 POWER
<p>Delicates</p> <p>Use this program to wash times requiring a gentle wash action. This would include blouses, nylons and dress shirts which are lightly soiled.</p>				
<p>Wool / Silk</p> <p>Use this program for washing delicate fabrics such as lingerie and woollens. (wash only "Water washable" clothes) Before washing your woollens check the care label for the washing instructions. (Wash only water washable clothes)</p>				
<p>Hand Wash</p> <p>Use this program to the light garment. (e.g. Inner wear, socks)</p>				
<p>Speed Wash</p> <p>Use this program for lightly soiled garments.</p>				
<p>Rinse/Spin</p> <p>When you only need the Rinse/Spin cycle, these can be set manually.</p>				

 Select the program on the Control panel.	 START/PAUSE	Finish	Caution & Note
			<ul style="list-style-type: none"> • Before starting to wash, make sure that the laundry is washable. Washing with HOT water may damage the laundry.
			<ul style="list-style-type: none"> • Delicates clothes (lingerie, wool, etc) which may be easily damaged can be washed. • The fibers of machine washable woolens have been specifically modified to prevent shrink when they are machine washed. • Most hand knitted garments are not made of machine washable wool and we recommend that you hand wash them.
			<ul style="list-style-type: none"> • Use only same kind of garments.
			<ul style="list-style-type: none"> • It reduce the washing time.
			

Delay Wash (Reservation)

Delay Wash (Reservation) is used to delay the finishing time of the operation. The hours to be delayed can be set by the user accordingly. The time on the display is the finishing time, not the start time.

1 Add the laundry into the washing tub.

2 Add the Detergent

3 Close the lid

- When the lid is open the machine will not operate, and an alarm Signal or “**EE**” will remind you to close the lid when it starts.

4 Press the **POWER** button to turn power on.



POWER

5 Press the **CYCLE** button to select the washing program.



6 Select desired Options.

SOIL LEVLE, WASH/RINSE, SPIN SPEED, BEEPER, SOAK, EXTRA RINSE

7 Press the **Delay Wash (Reservation)** button.



- The light of 'Delay Wash' will be turned on and 'TIME LEFT' **123** will be marked.
- Press the button repeatedly to set the desired finishing time. For example, To finish washing in 9 hours from now, by make the number 9:00 pressing the Delay Wash (Reservation) button repeatedly. (RES.=Delay)



8 Press the **START/PAUSE** button.



START/PAUSE

- When you press the START/PAUSE button the light will blink.

9 Finish

- The washing will be finished according to the delayed time.

Note

- Finishing time can be delayed from 1~24 hours. Delaying from 1~12 hours can be done in 1 hour time intervals and from 12~24 hours in 2 hour time intervals.
- If the lid is open, the machine will not work, and an alarm Signal or “**EE**” will remind you to close the lid.
- To select Spin Speed, water temp. or soil level manually, press the Delay Wash (Reservation) button and select the desired option. Then press the START/PAUSE button.
- When the laundry cannot be taken out immediately after the wash program ends, it is better to omit the spinning program. (The laundry will be wrinkled if left for a long time after spinning.)

Soak Wash

Use this mode to wash normal clothes or thick and heavy clothes which are excessively dirty. Soak mode can be used all program except Rinse/Spin.

1 Add the laundry into the washing tub.

2 Add the Detergent.

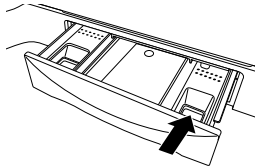

- Add the detergent in the right-hand compartment for Soak Wash cycle and in the middle compartment for main wash cycle.

3 Close the lid

- When the lid is open the machine will not operate, and an alarm Signal or “**EE**” will remind you to close the lid when it starts.

4 Press the **POWER** button to turn power on.



5 Press the **CYCLE** button to select the washing program.



- Select the cycle for laundry on the Control Panel.

6 Select desired Options.

SOIL LEVEL, WASH/RINSE, SPIN SPEED, BEEPER, EXTRA RINSE

7 Press the **Soak** button to change the soaking time.



- The following settings are indicated as the button is pushed.

15 ▶ 30 ▶ 45 ▶ 60 ▶ 120 ▶ 180min
▶ SOAK OFF

8 Press the **START/PAUSE** button.



Note

- The Soak wash cycle run prior to the main wash cycle.
- For some cycles, the water temperature for the soak cycle may not be the same as the water temperature for the main wash cycle.

Extra Rinse

This Program gives additional rinse cycle.

- 1 Press the **POWER** button to turn power on.



- 2 Press the **CYCLE** button to select the washing program.



- 3 Select desired Options.

SOIL LEVEL, WASH/RINSE, SPIN SPEED, BEEPER, SOAK, DELAY WASH

- 4 Press the **Extra Rinse** button to give additional rinse cycle.



- 5 Press the **START/PAUSE** button.



Note

- This CYCLE is for better rinsing effect.

Custom Program

Custom Program allows you to store a customized wash cycle for future use.

1 Add the laundry into the washing tub.

2 Add the Detergent

3 Close the lid

- When the lid is open the machine will not operate, and an alarm Signal or “**EE**” will remind you to close the lid when it starts.

4 Press the **POWER** button to turn power on.



5 Press the **CYCLE** button to select washing program.

- Bulky/Large ● Delicates
- Heavy Duty ● Wool/Silk
- Fuzzy ● Hand Wash
- Eco Cotton ● Speed Wash
- Perm. Press ● Rinse/Spin



6 Select desired Options.

SOIL LEVLE, WASH/RINSE, SPIN SPEED, BEEPER, SOAK, EXTRA RINSE, DELAY WASH

7 Press the **Custom Program** button for 3 seconds to store your Custom wash cycle.



8 Press the **START/PAUSE** button.



START/PAUSE

Note

To recall your Custom cycle.

1. Press **POWER** on.
2. Select the Custom cycle by pressing the **Custom Program** button.
3. Press the **START/PAUSE** button. Then the wash cycle starts.

Spin Only

When you only need the Spin cycles, this can be set manually.

1 Add the laundry into the washing tub.

2 Close the lid

- When the lid is open the machine will not operate, and an alarm Signal or “**EE**” will remind you to close the lid when it starts.

3 Press the **POWER** button to turn power on.



4 Press the **SPIN SPEED** button.



- The following settings are indicated as the button is pushed Low → Medium → High → Extra High → Low.

5 Press the **START/PAUSE** button.



Note

Fill laundry uniformly in the inner tub

Child Lock

If you want to lock all the keys to prevent settings from being changed during the wash operation by a child, you can use the child lock option.

How to Lock

1 Press the **POWER** button



- Turn Power on.

2 Press the **START/PAUSE** button to start washing.



START/PAUSE

- After all washing conditions are set according to the manual.

3 Press both the **SOIL LEVEL** button and the **WASH/RINSE** button simultaneously.



- During the wash program, all the buttons are locked until washing is completed or it is child-lock function is deactivated manually.

How to Unlock

If you want to unlock during wash, press both the **SOIL LEVEL** and the **WASH/RINSE** button simultaneously again.

Note

- “**CL**” & the remaining time are alternatively shown on the display while they are locked.

Placing and Leveling

Please ensure that transit restraint has been removed before operating your machine.

1 Place the machine on a flat and firm surface which allows proper clearance.

We suggest a minimum clearance of 2 cm to the right side and left sides of the machine for ease of installation.

At the rear, a minimum clearance of 10 cm is suggested.

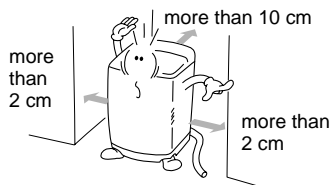

Caution

If the washer is installed on a uneven, weak or tilted floor causing excessive vibration, spin failure or "UE" error can happen to it.

It must be placed on a firm and level floor to prevent spin failure.

2 Set rear legs

Remove the level and tilt the washer forward (pivot on front legs) about 4 to 6 inches and gently lower the rear legs back onto the floor.

This action will set rear leg adjustments to correspond to front settings.

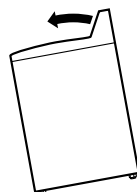

3 Check that the machine is level

Open the lid and look from above to see if it is same as shown.

Top view of the machine

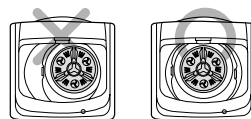

4 Leveling the machine

Lift the front of the washing machine and twist the Adjustable Leg until the surface bubble is placed in the center.

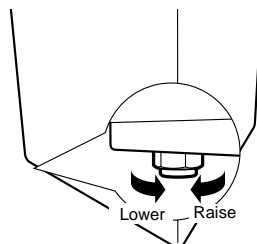

Caution

If the power is supplied from a cord extension set or generator, the cord extension set or electrical portable outlet device should be positioned so that it is not exposed to splashing or ingress of moisture.

Connecting Water Supply Hose

Before connecting the Water Supply Hose to the water tap, check the hose type and then choose the correct instruction here under.

Note that the Water Supply Hose supplied may vary from country to country, Make sure to connect the blue inlet hose to the COLD water tap, and the orange inlet hose to the HOT water tap.

Connecting Water Supply Hose to water tap

Normal Type(Normal tap without thread & screw type inlet hose.)

1 Untighten the screw

Untighten the screw of the connector so that the tap can be placed in the middle.

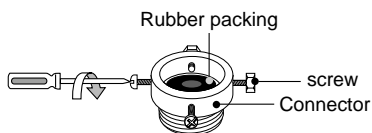

2 Fixing the connector to the tap

Push the upper connector up till the rubber packing is in tight contact with the tap. Then tighten the 4 screws.

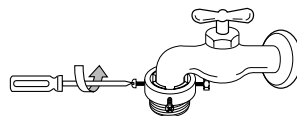

3 Attach the water supply hose securely to the connector

Push the water supply hose vertically upwards so that the rubber seal within the hose can adhere completely to the tap.

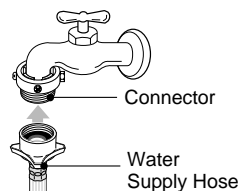

4 Fixing the connector to the water supply hose

Attach the water supply hose to the connector and then tighten it by screwing it to the right.

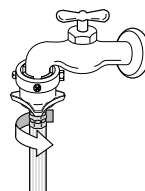

5 Check the connection of water supply hose and the connector

After connecting the hose, open the tap to check for any water leakage. If the water leaks, close the tap and start again from step 1.

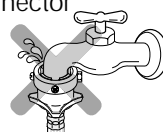

Note

The washing machine is to be connected to the water mains using new hose-sets and old hose-sets should not be reused.

Connecting Water Supply Hose

Normal Type (Normal tap without thread & one touch type inlet hose.)

1 Separate Middle connector from Water Supply Hose

Separate Middle connector from the Water Supply Hose by pulling the Pressing Rod and the Pressing Handle that is attached to the Water Supply Hose.

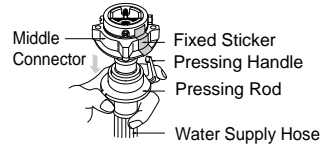

2 Loosen the fixed nuts to connect the connector to the tap

Untighten the screw of the connector so that the tap can be placed in middle.

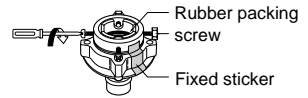

Note

In case tap is too large.

If the tap diameter is too large or is square, untighten the 4 screws and remove the guide plate. Then follow step 1.

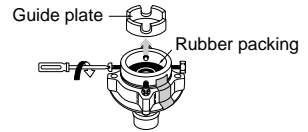

3 Fixing Connectors to the Tap

Push the upper connector up till the rubber packing is in tight contact with the tap. Then tighten the 4 screws.

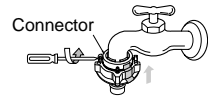

4 Fixing Upper Connector and Middle Connector

Remove the fixed sticker in between the Upper and Middle Connectors. Tighten the connectors by holding one connector and twist middle connector to the right.

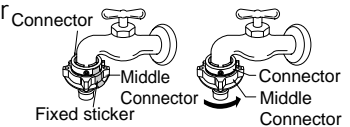

5 Connecting Middle Connector and water Supply Hose

Press down the pressing rod of the Water Supply Hose which was separated from middle connector (refer to Step 1) and then join it to the middle connector.

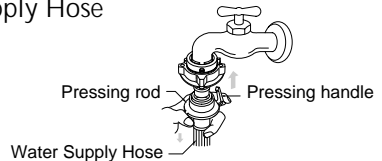

6 Check for water leakage

After connecting the hose, open the tap to check for any water leakage.

If the connection leaks, close the tap and start again from step 1. If you skip step 1, water leakage may occur.



Connecting Water Supply Hose

Screw Type

1 Attach the water supply hose to the tap.

Push the water supply hose up so that the rubber packing within the hose can adhere completely to the tap.

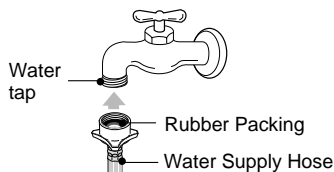

2 Connect the water supply hose to the tap.

Connect the water supply hose to the tap and then tighten it by screwing it to the right.

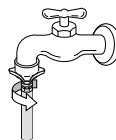

3 Check water leakage.

After connecting the hose to both the tap and the washing machine, open the tap to check for any water leakage.

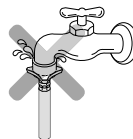

Connecting Water Supply Hose to the machine

- Connect the water supply hose to inlet valve of the washing machine, and then lock it by turning the hose connecting part.
- Check to see if there is a rubber seal inside the connector before screwing to the tap.

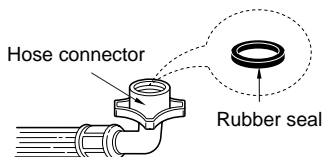
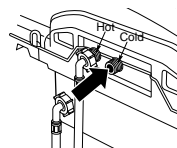

Connecting Drain Hose

Before connecting Drain Hose, check your Drain Hose model and choose the correct instructions.

How to install the drain hose

- 1 Fit the end of the drain hose to the outlet of the drain pump and tighten the clamp.

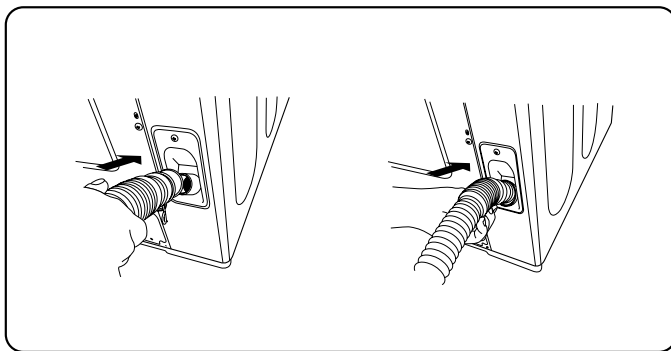

- 2 Firmly insert the free end of the drain hose into the drain opening of your home. Make sure the soft rubber end is completely inside the drain opening.

- If the water valves and drain are built into the wall, fasten the drain hose to one of the water hoses with the cable tie (ribbed side on inside).
- If your drain is a standpipe, fasten the drain hose to the standpipe with the cable tie provided.

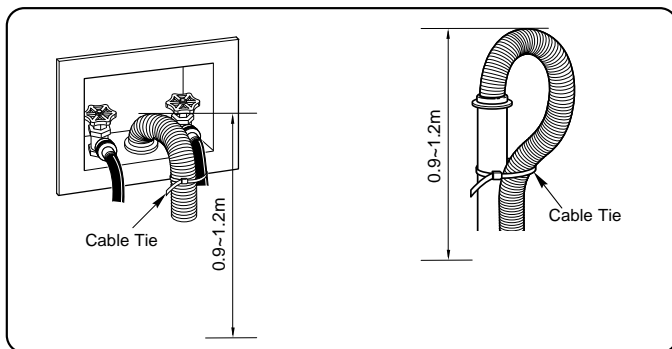

Note

The discharge height should be approximately 0.9~1.2m from the floor.
Do not lay down the drain hose during wash mode.

Grounding Method

Earth wire should be connected.

If the earth wire is not connected, there is possible a danger of electric shock caused by the current leakage .

Grounding Method with Ground insert space Terminal

If the AC current outlet has a ground terminal, then separate grounding is not required. Note that AC power outlet configurations may differ from country to country.

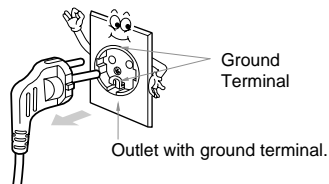

Caution

CAUTION concerning the Power Cord

Most appliances recommend they be placed upon a dedicated circuit; that is, a single outlet circuit which powers only that appliance and has no additional outlets or branch circuits. Check the specification page of this owner's manual to be certain. Do not overload wall outlets. Overloaded wall outlets, loose or damaged wall outlets, extension cords, frayed power cords, or damaged or cracked wire insulation are dangerous. Any of these conditions could result in electric shock or fire. Periodically examine the cord of your appliance, and if its appearance indicates damage or deterioration, unplug it, discontinue use of the appliance, and have the cord replaced with an exact replacement part by an authorized servicer. Protect the power cord from physical or mechanical abuse, such as being twisted, kinked, pinched, coiled in a door, or walked upon. Pay particular attention to plugs, wall outlets, and the point where the cord exits the appliance.

Other Grounding Method

Burying Copper Plate

Connect the Ground Wire to a Ground Copper Plate and bury it more than 75cm in the ground.

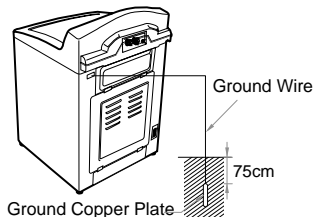

Using Ground Wire

Connect the Ground Wire to a the socket provided exclusively for grounding

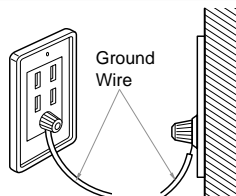

Using a Short Circuit Breaker

If grounding methods described above are not possible, a separate circuit breaker should be employed and installed by a qualified electrician

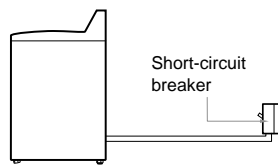

Caution

- To prevent a possible explosion, do not connect ground to a gas pipe.
- Do not connect ground to telephone wires or lightning rods. This may be dangerous during electrical storms.
- Connecting ground to plastic has no effect.
- Ground wires should be connected when an extension cord is used.

Cleaning and Maintenance

Cold water washing

- If you always use COLD water, we recommend that a WARM or HOT wash be used at a regular intervals e.g. every 5th wash should be at least a WARM one.

When you have finished

- Turn off taps to prevent the chance of flooding should a hose burst.
- Always unplug the power cord after use.

When water supply into the tub is not clean or the filter is clogged with particles (such as sand), clean the filter in the inlet valve occasionally.

(The figure of power cord and water tap may vary according to the country)

To Clean the Filter in the Inlet Valve

- 1** Close the tap before turning off the power. Select both Hot/Cold and then press the [START/PAUSE] button to remove water from the machine completely.



- 2** Turn off the power before pulling out the cord.

- 3** After removing the water supply hose pull out the filter. Then use a brush to clean the filter.

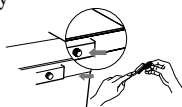

- 4** Replace the filter after cleaning it.

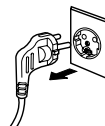

Caution

- Before cleaning the filter, the impurities in the water supply hose should be removed.

Cleaning and Maintenance

When there is a fear of freezing

- Close the water taps and remove the Water Supply Hose.
- Remove the water which remains in the water supply.
- Lower the drain hose and drain the water in the bowl and the drain hose by spinning.

If frozen

- Remove the water supply hose, and immerse it in HOT water at approx..40° C.
- Pour approx..2 liters of HOT water at approx..40° C, into the bowl and let it stand for 10 minutes.
- Connect the water supply hose to the water tap and confirm that the washing machine performs the supply and drainage of water.

Wash Inner-Tub

Leave the lid open after washing to allow moisture to evaporate. If you want to clean the inner-tub use a clean soft cloth dampened with liquid Detergent, then rinse. (Do not use harsh or gritty cleaners.)

Inlet Hoses Exterior

Hoses connecting washer to faucet should be replaced every 5 years. Immediately wipe off any spills. Wipe with damp cloth. Try not to hit surface with sharp objects.

Long Vacations

Be sure water supply is shut off at faucets. Drain all water from hoses if weather will be below freezing.

Cleaning the Inside of your Washer

If you use fabric softener or do regular COLD water washing, it is very important that you occasionally clean the inside of your washer.

- Fill your washer with HOT water.
- Add about two cups of a powdered Detergent that contains phosphate.
- Let it operate for several minutes.
- Stop the washer, open the lid and leave it to soak overnight.
- After soaking, drain the washer and run it through a normal cycle.

Products that might damage your washing machine

- Concentrated bleaches and diaper sanitizer will cause damage to the paintwork and components of your washer.
- Hydrocarbon solvents i.e. petrol, paint thinners and lacquer thinners, etc. can dissolve plastic and blister paint (Be careful when washing garments stained with these solvents as they are flammable DO NOT put them in washer or dryer.)
- Some pretreatment sprays or liquids can damage your washer's control panel.
- Use of dyes in your washer may cause staining of the plastic components. The dye will not damage the machine but we suggest you thoroughly clean your washer afterwards. We do not recommend the use of dye strippers in your washer.
- Do not use your washer lid as a work surface.

Common washing problems











Many washing problems involve poor soil & stain removal, residues of lint and scum, and fabric damage. For satisfactory washing results, follow these instructions.

WASH PROBLEM

Problems	Possible Causes	Solutions & Preventive Measures
Poor soil removal	<ul style="list-style-type: none"> • Not enough Detergent • Wash Water Temperature too low. • Overloading the washer • Incorrect wash cycle • Incorrect sorting • Do not pretreat stain. 	<ul style="list-style-type: none"> • Use correct amount of Detergent for load size, amount of soil and water Hardness. • Use WARM or HOT water for normal soil. Different Water Temperature may be required according to soil type. (<i>refer to page 10</i>) • Reduce load size. • Wash with Heavy or Soak & Heavy wash cycle for heavy soiled laundry. • Separate heavily soiled items from lightly soiled ones. • Pretreat stain and heavy soil according to directions shown on page 9.
Blue Stains	<ul style="list-style-type: none"> • Undiluted fabric softener dispensed directly onto fabric 	<ul style="list-style-type: none"> • Rub the stain with bar soap Wash. • Do not overfill fabric softener dispenser and do not pour liquid fabric softener directly onto fabric. See page 12 for more instructions.
Black or gray marks on clothes	<ul style="list-style-type: none"> • A buildup caused by the interaction of fabric softener and Detergent can flake off and mark clothes • Not enough Detergent 	<ul style="list-style-type: none"> • Keep the recommendations against Scrud(waxy buildup). • Use correct amount of Detergent for load size, amount of soil and water Hardness.
Yellow or brown rust stains	<ul style="list-style-type: none"> • Iron or manganese in water supply, water pipes, or water heater 	<ul style="list-style-type: none"> • To restore discolored load of whites, use rust remover safe for fabric. • Install nonprecipitating water softener or an iron filter in your water supply system for an ongoing problem. • Before washing, run water for a few minutes to clear lines.
Lint	<ul style="list-style-type: none"> • Incorrect sorting • Tissues left in pocket • Overloading the washer 	<ul style="list-style-type: none"> • Wash lint givers eg towels, flannelette sheets, separately from lint collectors e.g. synthetic fabrics and remove tissues in pockets before wash. See page 9 for sorting and caring before loading. • Do not overload the washer
Residue or Detergent	<ul style="list-style-type: none"> • Overloading the washer • Undissolved Detergent • Use too much Dtergent 	<ul style="list-style-type: none"> • Do not overload the washer. • Some Detergents need to be pre-dissolved, check the Detergent instructions. Try pre-dissolving the Detergent. • Increase Water Temperature using HOT water safe for fabric. • Use proper amount of Detergent.
Holes, tears, or snags	<ul style="list-style-type: none"> • Incorrect use of chlorine bleach. • Unfastened zippers, hooks, buckles • Ribs, tears and broken threads • Overloading the washer • Degradation of fabric 	<ul style="list-style-type: none"> • Never pour chlorine bleach directly on fabric. See page 11 for adding liquid bleach. • Fasten zippers, hooks, and buckles. • Remove objects in pockets. See page 9 for caring before loading. • Do not overload the washer.

Troubleshooting

- If an abnormal symbol appears in the display window, check the following before asking for service.
- Request for the service center or agent in the case of failure or damage except for the following.
- This appliance is fitted with a safety function that automatically stops the operation of the washing machine when it is exposed to heavy disturbance on the mains.

Symptom	Error Message	Check up
Water Supply Failure		<ul style="list-style-type: none"> • Is the water tap shut off? • Is the water supply cut off? • Is the tap or water supply hose frozen? • Is the water pressure low or is the filter of the inlet valve clogged with impurities? • Is the Hot hose connected to cold? • Is the Cold hose connected to hot? <p>※ If the Washing Machine is working under bad supply of water, "1E" is on the DISPLAY.</p>
Drainage Failure		<ul style="list-style-type: none"> • Is the drain hose positioned correctly? • Is the drain hose bent or placed too high? • Is the internal part of the hose or drain pump (only pump model) clogged with impurities? • Check if power has gone off.
Spin Failure		<ul style="list-style-type: none"> • Is the laundry evenly balanced? • Is the washing machine placed on a flat surface?
Door(Lid) Open		<ul style="list-style-type: none"> • Is the lid closed?
Abnormal level sensing		<ul style="list-style-type: none"> • Please call your nearest LG Electronics service center for help.
Overflow failure		
Abnormal motor		
Brake Resister Error		
Clutching Error		
Coupling Error		

Terms of Warranty

What Is Not Covered:

- Service trips to your home to teach you how to use the product.
- If the product is connected to any voltage other than that shown on the rating plate.
- If the fault is caused by accident, neglect, misuse or Act of God.
- If the fault is caused by factors other than normal domestic use or use in accordance with the owner's manual.
- Provide instruction on use of product or change the set-up of the product.
- If the fault is caused by pests for example, rats or cockroaches etc..
- Noise or vibration that is considered normal for example water drain sound, spin sound, or warning beeps.
- Correcting the installation for example, levelling the product, adjustment of drain.
- Normal maintenance which recommended by the owner's manual.
- Removal of foreign objects / substances from the machine, including the pump and inlet hose filter for example, grit, nails, bra wires, buttons etc.
- Replace fuses in or correct house wiring or correct house plumbing.
- Correction of unauthorized repairs.
- Incidental or consequential damage to personal property caused by possible defects with this appliance.
- If this product is used for commercial purpose, it is not warranted.
(Example : Public places such as public bathroom, lodging house, training center, dormitory)

If the product is installed outside the normal service area, any cost of transportation involved in the repair of the product, or the replacement of a defective part, shall be borne by the owner.

S

pecification

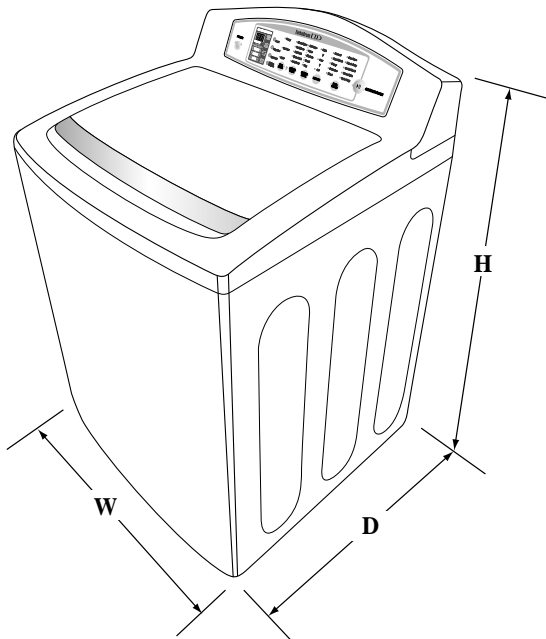

Model	WT-R107
Size	685(W) X 720(D) X 1095(H)
Weight	58kg
Water tap pressure	30-600 kPa(0.3-6.0 kgf/ cm ²)
Wash Capacity	10kg

※ In our continuing effort to improve the quality of our appliances, it may be necessary to make changes to the appliance without revising this manual.